



STANDARD

Comply with ANSI/EIA RS-310-D, DIN41491; PART1, IEC297-2, DIN41494; PART7, GB/T3047.2-92 standard.
Compatible with metric, ETSI and 19" international standard.

FEATURES

- Exquisite design with precise dimension and craftsmanship.
- International popular smoky-gray glass front door.
- Easily be mounted on wall, or placed on floor after installed castor or feet.
- Loading capacity: 60KG.
- Top and bottom wiring channel could be closed.
- Removable front door and side panel, easily installing and maintaining
- Surface finish: Degreased, acid cleaned, phosphoric, water cleaned, electro-static powder coating, meet ROHS standard.
- Optional color: black/gray
- Optional accessories.

MATERIALS

Cool rolled steel
Thickness: Mounting rail: 2.0mm
Else in 1.2mm
Tempered smoky-gray glass with thickness of 5mm.

APPLICATION

Widely used in network system, educational system, broadcasting system and telecommunication system. Suitable for placing server computer and precision electronic equipments.



Cabinet Fans



Mounting Rail



Lockable Side Panels



Top View

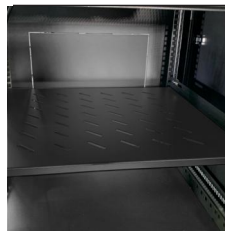

Equipment Tray



Side View

STRUCTURAL (SPLIT TYPE)

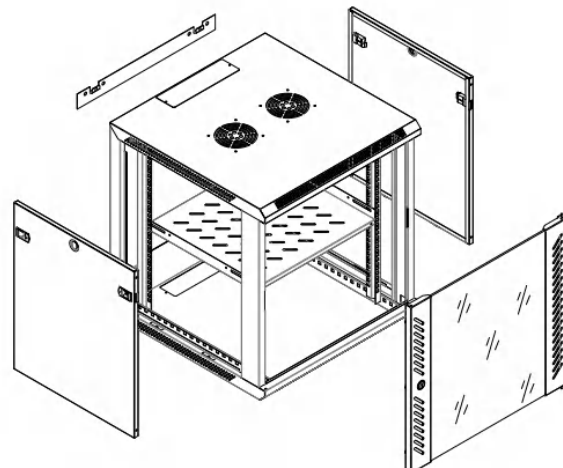

STANDARD ACCESSORIES

S/N	Specification	Qty	Unit	Material	surface finish	Remark
1	Frame	2	Pcs	1.2mm cold rolled steel	Powder coated	---
2	Front door	1	Pcs	1.2mm cold rolled steel	---	D type door
3	Side door	2	Pcs	1.2mm cold rolled steel	Powder coated	With lock
4	Round lock	1	Pcs	---	---	---
5	Mounting rail	4	Pcs	2.0mm cold rolled steel	Powder coated	---
6	Mounting plate	1	Pcs	1.5mm cold rolled steel	Powder coated	---
7	Cable inlet cap	2	Pcs	1.2mm cold rolled steel	Powder coated	---
8	Screws &nuts	20	sets	---	---	---
9	wrench	1	Pcs	---	---	---

ORDER INFORMATION

Part No :	Capacity (U)	Width (mm)	Depth (mm)	Height (mm)	Carton measurement W×D×H(mm)	Volume (CBM)
CR2106645-■■■	6U	600	450	368	670×520×430	0.15
CR2109645-■■■	9U	600	450	501	670×520×560	0.20
CR2112645-■■■	12U	600	450	635	670×520×700	0.24
CR2115645-■■■	15U	600	450	769	670×520×830	0.29
CR2118645-■■■	18U	600	450	901	670×520×960	0.33
CR210666-■■■	6U	600	600	368	670×670×430	0.19
CR210966-■■■	9U	600	600	501	670×670×560	0.25
CR211266-■■■	12U	600	600	635	670×670×700	0.31
CR211566-■■■	15U	600	600	769	670×670×830	0.37
CR211866-■■■	18U	600	600	901	670×670×960	0.43

* Please contact us for customized requirement

TYPE DESCRIPTION

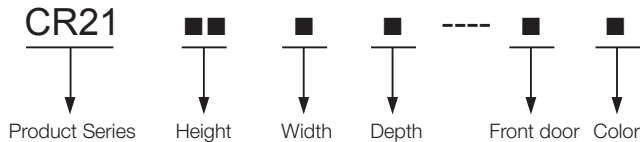

COLOR

■■■■■■■■■-■■■1
1= Black(RAL9004)
■■■■■■■■■-■■■2
2= Gray(RAL7044)

DOORS

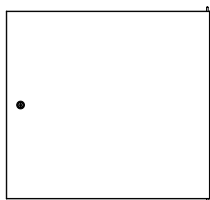

A: Steel Casement Door

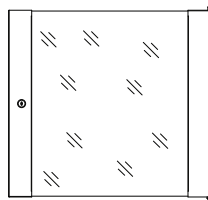

B: Smoky-grey Glass Door

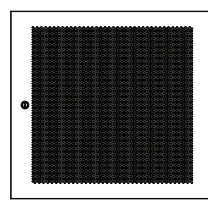

C: Perforation Steel Door With High Ventilation Level(Hexagonal Type)

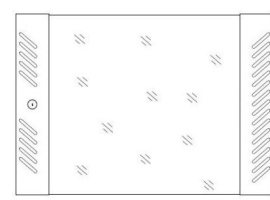

D: Smoky-grey Glass Door With Blade Hole